

A Novel Proton Exchange Membrane Fuel Cell-Battery Partial Hybrid System Design for Unmanned Aerial Vehicle Application



Dr. Mebs Virji

Hawaii Natural Energy Institute
University of Hawai'i at Mānoa

Hybrid SMALL FUEL CELLS

Knowledge Foundation's 14th Annual International Symposium
July 18th, 2012

OUTLINE

- **Objective & Approach**
- **Hybridization of Fuel Cell Systems – Why?**
- **Rationale for Novel Partial Hybrid System**
- **Novel Partial Hybrid System Design**
 - **Pros & Cons**
 - **Design Considerations**
 - **System Simulation Study & Results**
 - **Hardware-in-the-Loop (HiL) Methodology & Setup**
 - **Prototype Controller Design**
 - **Real-Time HiL Test & Energy Balance Results**
- **Conclusions**



OBJECTIVE AND APPROACH

- **Improve the design of the most commonly used UAV hybrid system**
- **Comparison between three UAV Systems**
 - **Novel Partial Hybrid (PH) System**
 - **Non-Hybrid (Load Following (LF)) and Full Hybrid (FH) Systems**
- **Methodology for Characterization and Performance Comparison**
 - **System Simulation for 24+ hours Endurance**
 - Full tank of fuel
 - Fully charged battery pack
 - Repeated 20 minutes load profile
 - **Hardware-in-the-Loop (HiL) Testing System for Real Time Study**
 - Prove of concept test for the PH system with a prototype hardware controller, PEMFC stack, Battery Pack and balance of plant (BoP) components
 - Comparison of Simulation Vs HiL Results
 - System performance with different operational strategies
 - UAV flight duration estimate using energy balance results under a 20 minutes load profile



Hybridization of Fuel Cell System – Why?

Hybridization Benefits:

- Fuel Cell does not meet power demand for several reasons

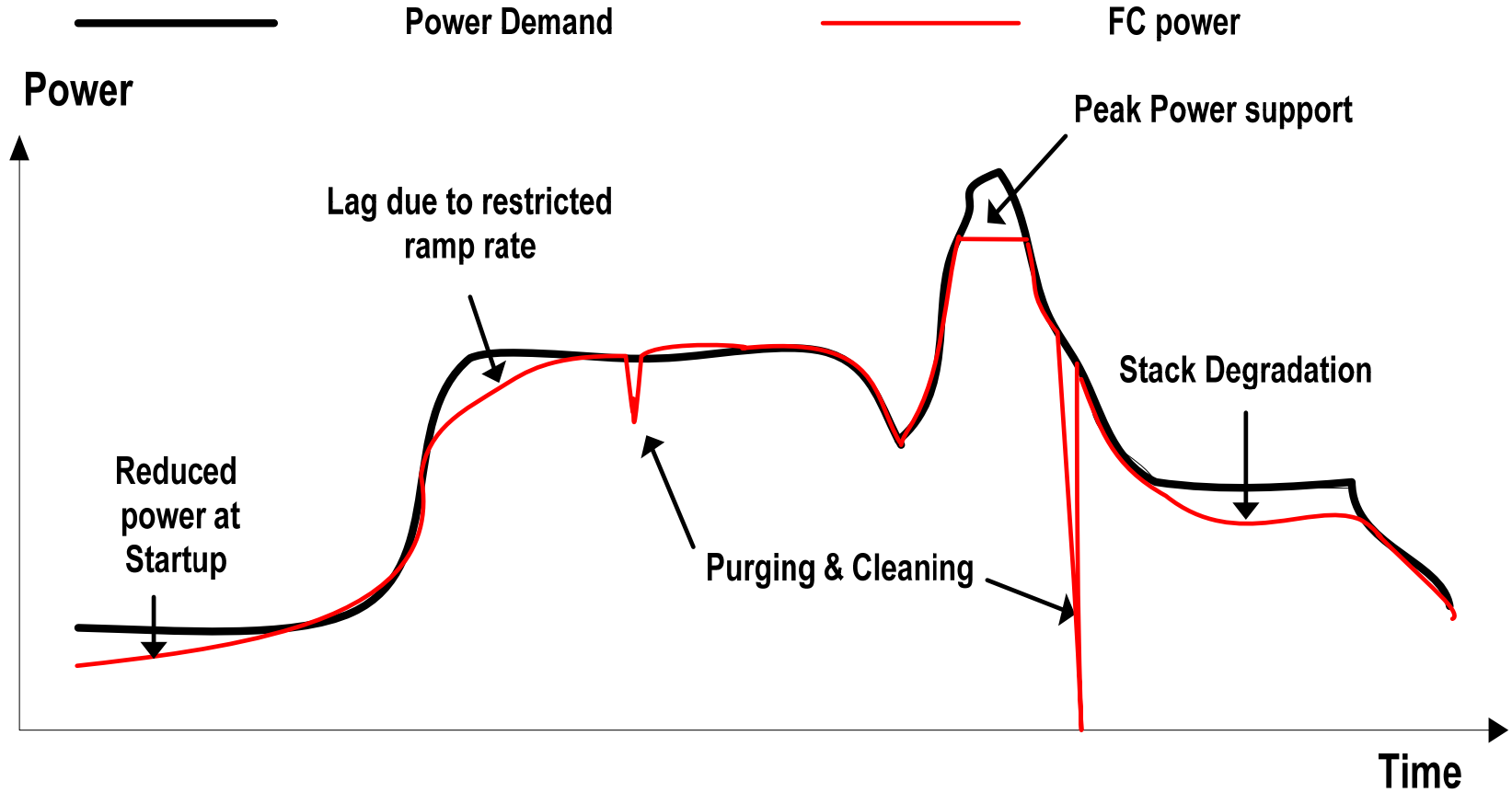

Rationale for Novel Partial Hybrid System

PH Hybrid System resolves the main issues of the most commonly used Hybrid System - Full Hybrid

- **Battery pack weight penalty**
 - ⇒ *Potential to reduce battery pack size and weight*
- **Large dc-dc converter**
 - Same power rating as the Fuel Cell Stack
 - Weight penalty
 - High power losses through converter
 - ⇒ *Use smaller dc-dc converter and weight*
 - ⇒ *Minimizes power losses of the dc-dc converter*
- **Battery can be discharged quickly at continuous peak power**
 - ⇒ *Control the use of battery during peak power*
 - ⇒ *Optimize battery energy to minimizes the stack power and dynamics by sharing the load demand*
- **Fuel Cell Stack can't provide power to the system directly**
 - ⇒ *Flexibility to switch to different mode of operations*

Novel Partial Hybrid (PH) System Design

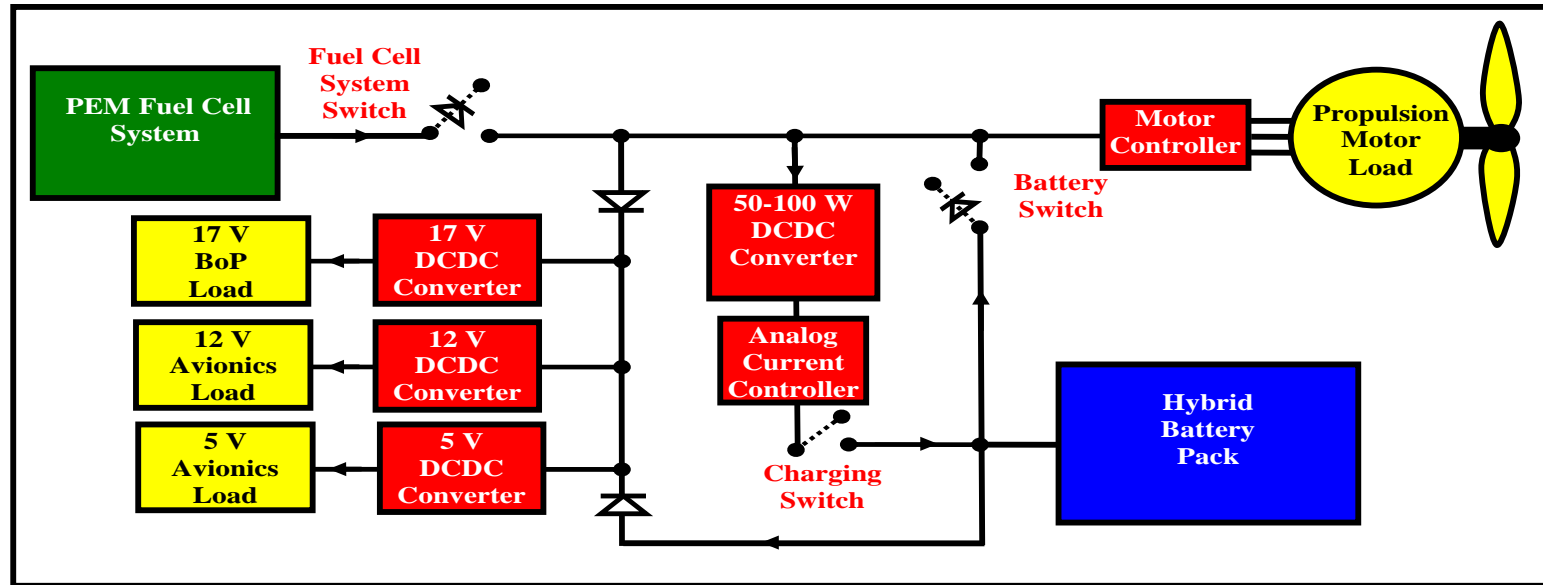

• System Components:

- 500W PEMFC Stack
- 60Wh Battery Pack Size
- Propulsion Motor & Controller
- Smaller dc-dc converter (~100W)
- Three ancillary Loads (17V, 12V & 5V)
- Control Switches (2 x “Zero-Volts” Diode & 1 for Battery Charging)

• Flexible Modes of Operation:

- Parallel
 - Battery and fuel cell supply power to the system
 - Battery voltage regulates the stack power
- Charging
 - Fuel cell supplies system and charging power when demand is < average system power
- Load Following when Battery State of Charge < 30%
 - Fuel cell supplies all the power to the system including battery charging power
 - Battery charging mode is controlled

UAV Systems Pros & Cons

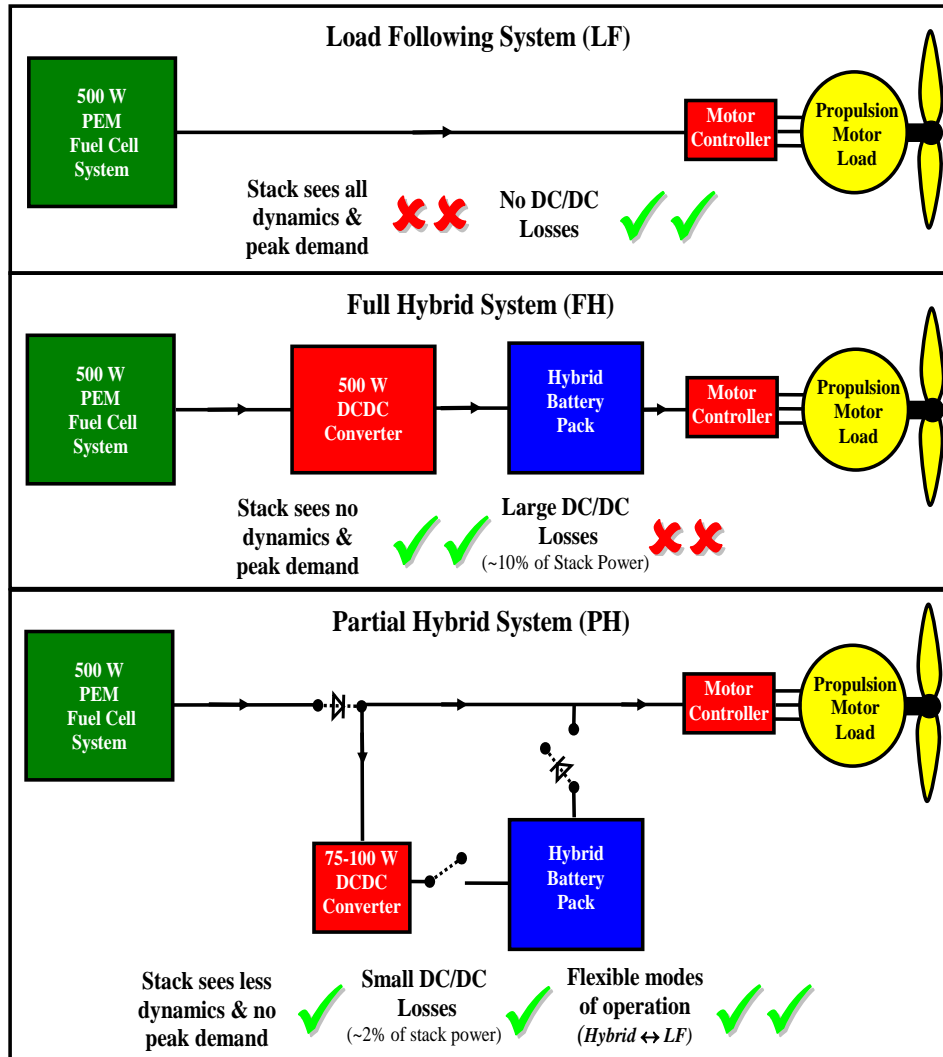

* Ancillary loads not shown

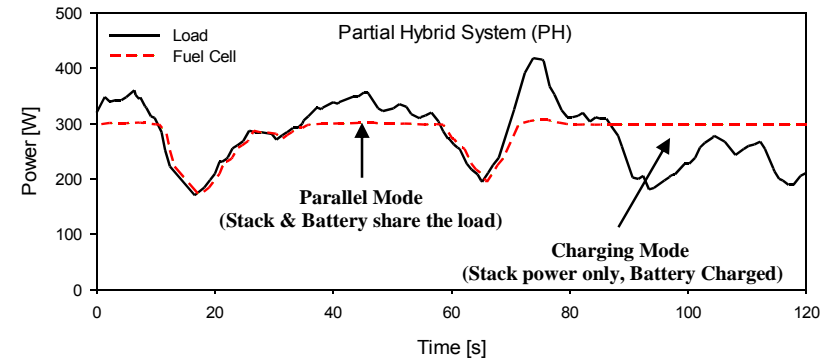
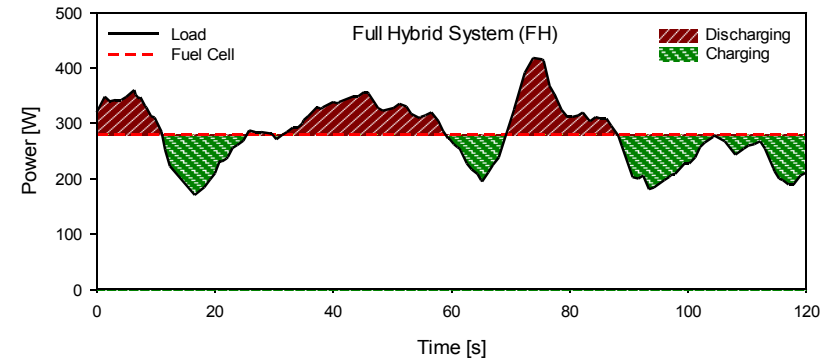
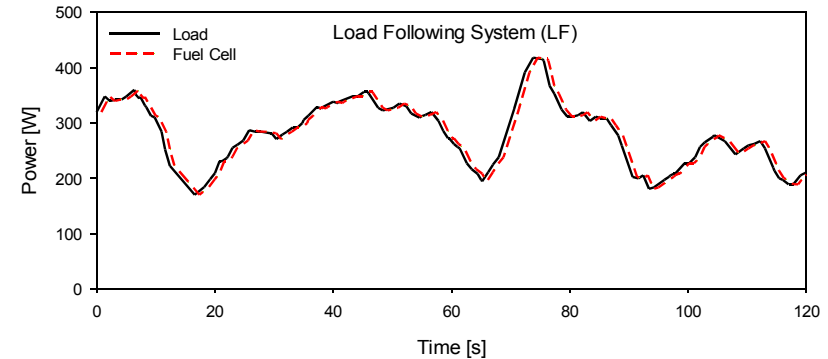

Partial Hybrid System Design Considerations

• DC-DC Converter Size

- Large enough to maintain battery state of charge (SoC) between 50-60%
- Small enough to minimize power losses and weight penalty

• Battery Pack Size

- Voltage optimized for parallel/charging mode ratio
- Voltage range in operating range of motor controller
- Pack size should be small to minimize weight penalty

• Controller Algorithm

- Determines modes of operation as a function of system demand & SoC of battery
- Determines when battery is allowed to be charged
- Determines when the stack power is load leveled and utilizes excess fuel cell power to charge the battery pack (only in simulation study)

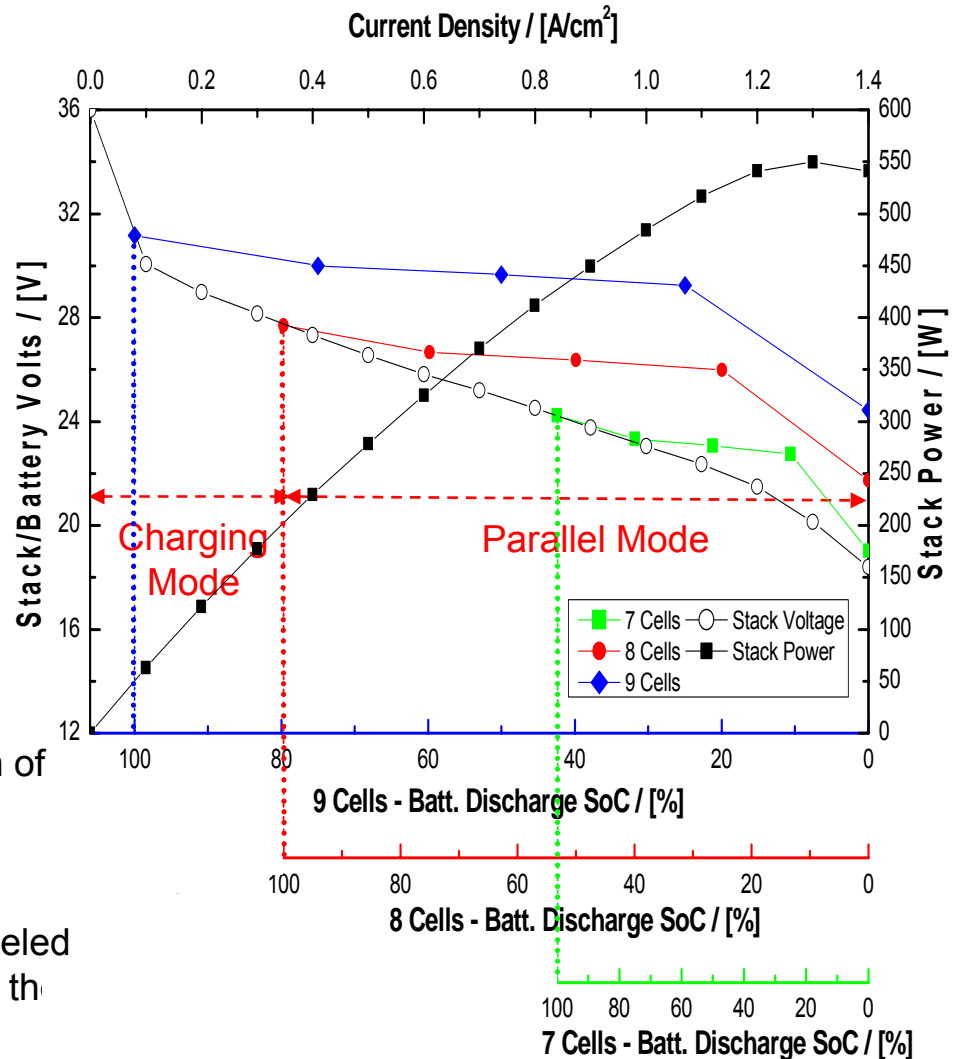

Fuel Cell System Simulation Tool: UAV Simulation

- Simulation developed in Matlab & Simulink environment

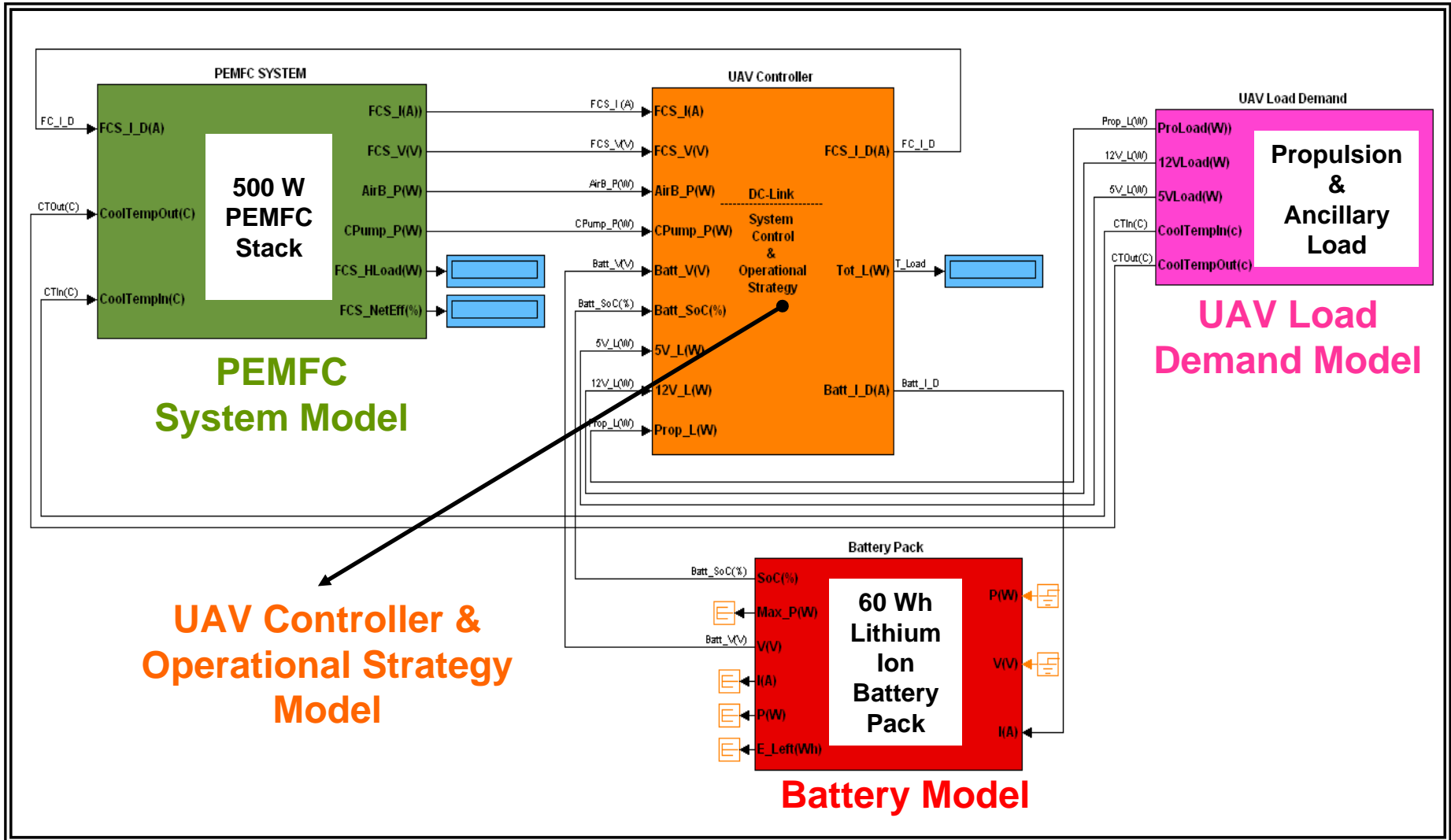

Fuel Cell System Simulation Tool

- **Adaptable to any fuel cell and hybrid systems and components**
 - UAV, UUV, Auto-FCV, Stationary-CHP
 - Load Following (LF), Partial Hybrid (PH) or Full Hybrid (FH)
 - Fuel Cell, Batteries or Super capacitor
 - Liquid and Gaseous Fuel tanks
- **Characterization of overall system and components performance**
 - Mission profiles, drive cycles, dynamic load profiles
 - Operating conditions (temperature, pressure, relative humidity, stoichiometry)
 - Operating strategies (LF, PH, FH, dead-end, purge cycle, oxide clean-up)
 - Control strategies (operating components at constant, average, dynamic modes)
- **Easily converted to real time simulations for Hardware-in-the-Loop use**
 - System components under realistic dynamic conditions

Simulation Setup for 24+ Hrs Endurance Test

• Propulsion Load Profile & System Weight Penalty:

- 20 mins Load Profile: Repeated to calculate the final duration of the UAV Mission
- Repeated Until: 0.5 k of H₂ is consumed and SoC% Battery ≤ 10%
- Total weight penalty: Increase in propulsion power for hybrid systems

• System Ancillary Loads:

- Zero Avionics + BoP
- Nominal Avionics (cruise) + BoP
- Maximum Avionics (peak) + BoP
 - ~ 2.5 X Nom. Avionics

• DC-DC Converter Efficiency

- 90-93%

• PEMFC System

- Nom. Power: 500 W
- Stack Temp : 50-55°C
- Anode Stoich: 1.02
- Cathode Stoich: ~ 2.5

• Battery Pack: Lithium Ion

- Capacity: 2.3 Ah
- Nom. Voltage: 3.3 volts/Cell
- Initial SoC: 100%

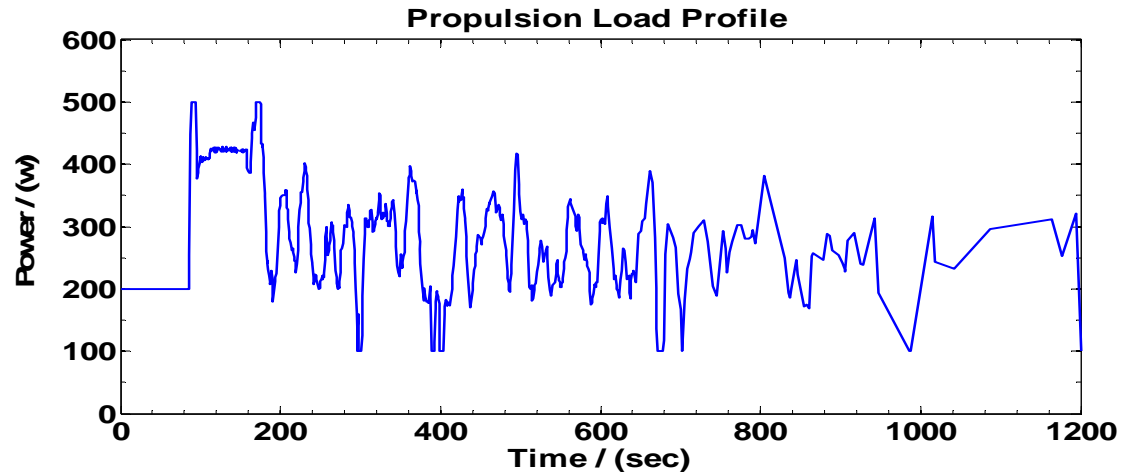

UAV SYSTEM TYPES	LF	FH	PH
No of Cells of Lithium Ion	4	8	8
Increase in Battery Wt (g) (70g/cell)	0.0	280	280
Increase in Electronics Wt (g) DC-DC Converter/MOSFET/Diodes	0.0	100	112
Net Increase in System Weight (g)	0.0	380	392
Net Increase in Propulsion Power (W)	0.0	7.54	7.78

Flight Endurance Results

Maximum Flight Duration with 0.5 kg of H₂ and a fully charged Battery Pack

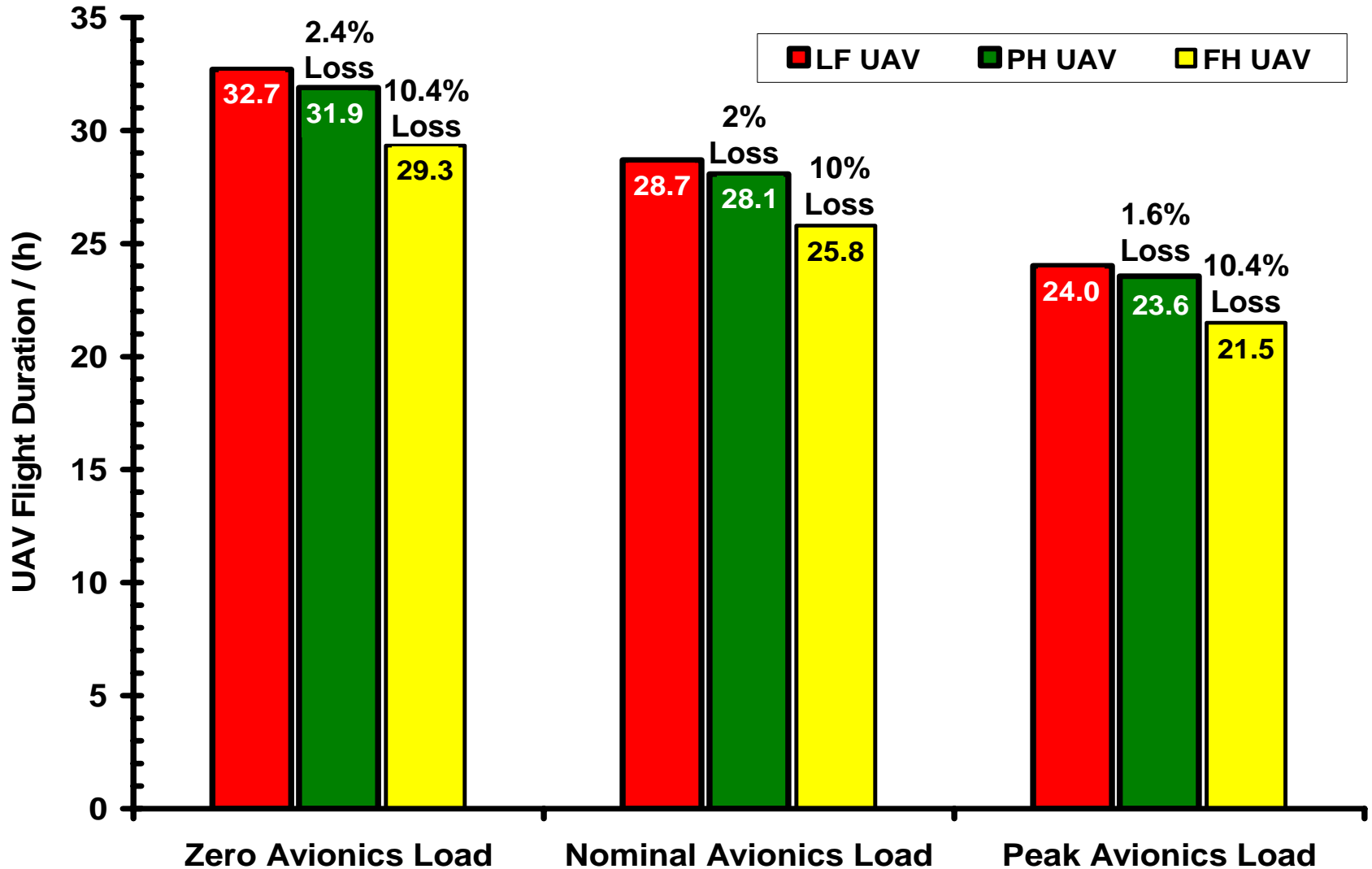

HiL Test System Operational Concept

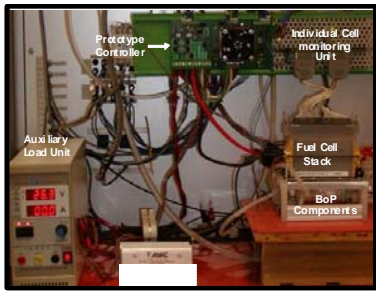
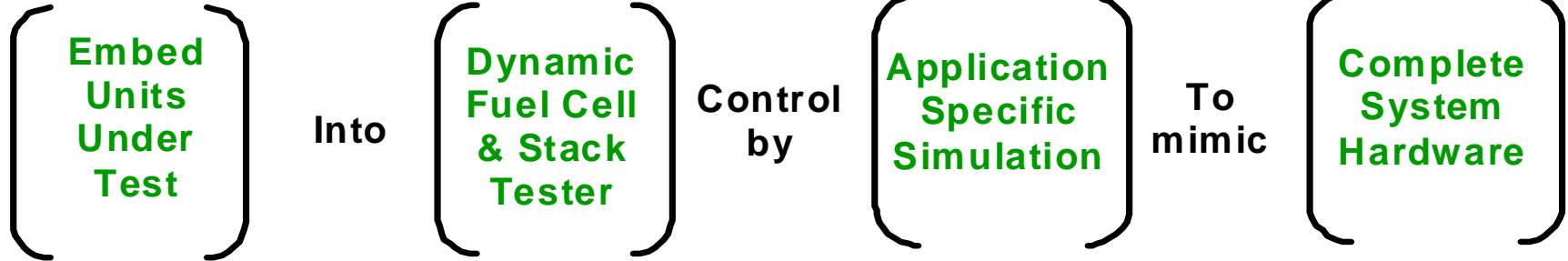

Unit Under Test
(Stack, Cell, Blower, Humidifier, Battery Pack, etc)

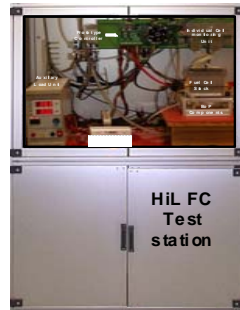
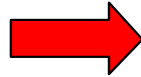

Simulator
(Valves, MFC, load unit, cooling system, etc)

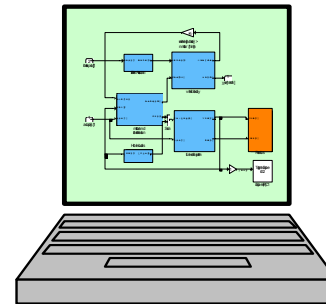

Simulation
(Fuel Cell and Hybrid systems, control, load profile, etc)



Application
(Unmanned Aerial Vehicle, Fuel Cell Hybrid Vehicle, etc)

Prototype Hardware Controller

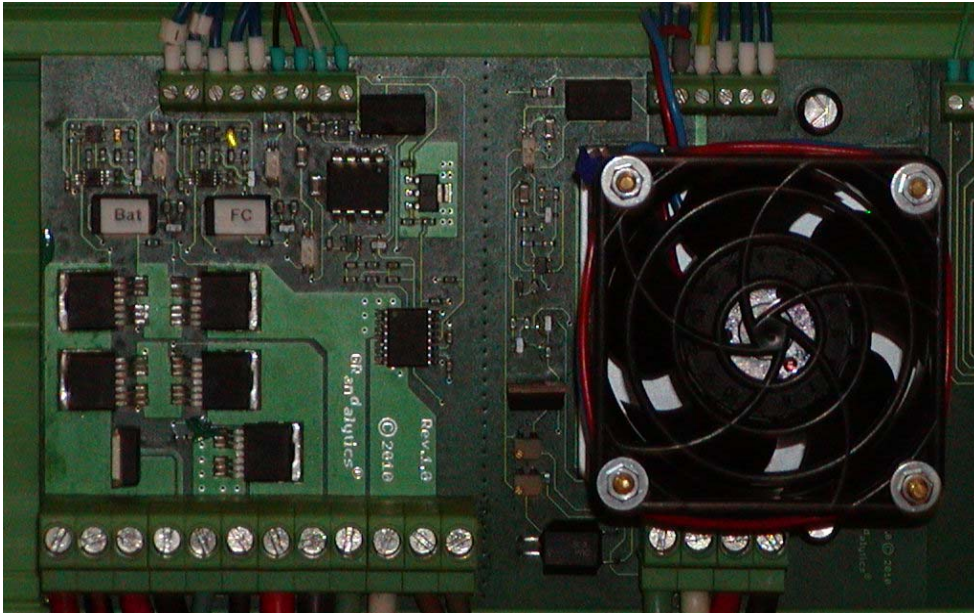

Controller consists of:

- 2 “Zero-Volts” Diode Switches
Measured Losses (0.3-0.5 W)
- 1 Charging Switch (MOSFET)
- 2 Schottky Diodes
Measured Losses (1-2 W)
- DC-DC Converter
 - Sized to ~ 100 W
 - Input voltage range 18-36 V
 - Output voltage range 16-30 V
 - Average Efficiency ~ 90%
- Isolated battery voltage & current measuring circuits

• PH system controller and control algorithm designed to:

- Enable safe operation and switching between different modes of operations
 - Parallel mode –fuel cell and battery share the system load
 - Load Following mode –fuel cell supplies all the power to the system
 - Charging mode –fuel cell charges the battery via the DC-DC converter
- Enable safe supply of the ancillary load by the fuel cell and/or battery (no power back flow)
- Measure battery current and voltage – for battery SoC estimate

Simulation Setup for 20 mins HiL Test

- **Load Demand:**
 - 20 mins UAV Load Profile
- **System Auxiliary Load:**
 - Nominal Avionics (cruise) + BoP
- **PEMFC System**
 - Nom. Power: 500 W
 - Stack Temp : 50-55°C
 - Anode Stoich: 1.02
 - Cathode Stoich: ~ 2.5
- **Battery Pack: Lithium Ion**
 - Capacity: 2.14 Ah (7% de-rated)
 - Nom. Voltage: 3.3 volts/Cell (8 Cells)
 - Initial SoC: 100%
- **Battery SoC Estimation:**
 - SoC of battery is estimated by integrating the charge and discharge currents over time
 - Future: Use of Resistance method
- **Charging Algorithm:**
 - Charges battery at constant current
 - Minimizes the current spike by voltage matching

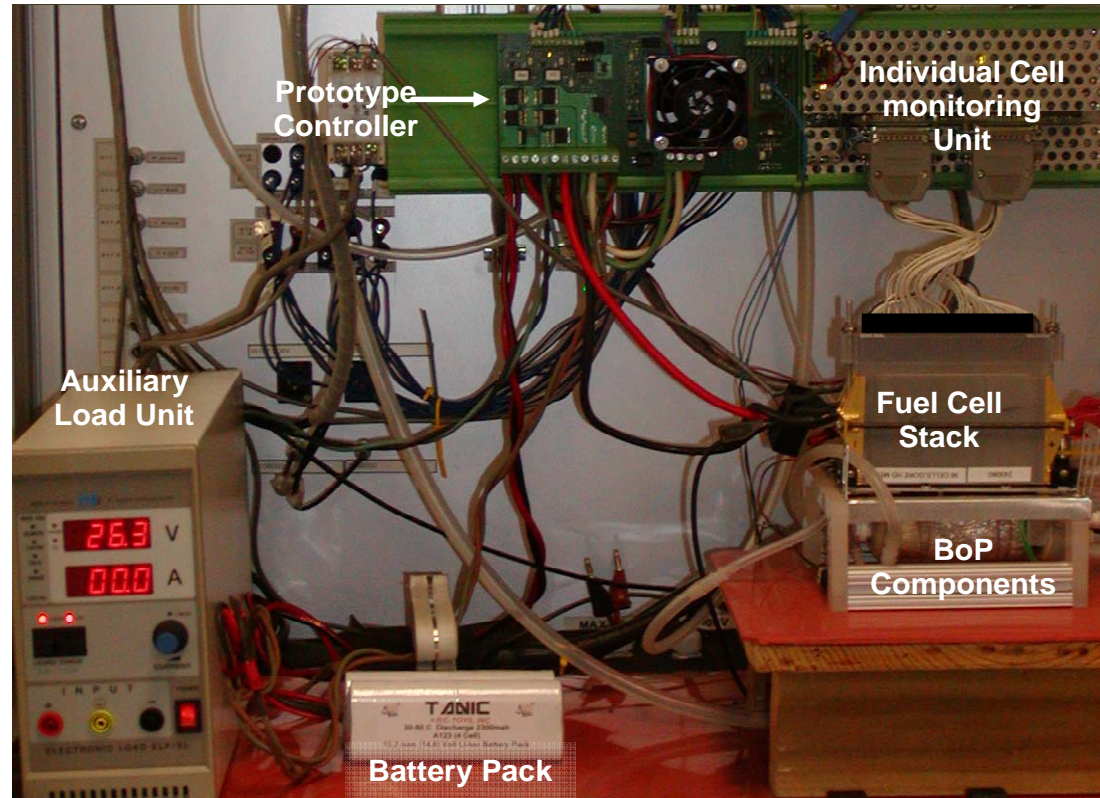

Demonstration of PH System with Prototype Controller on the HiL Station

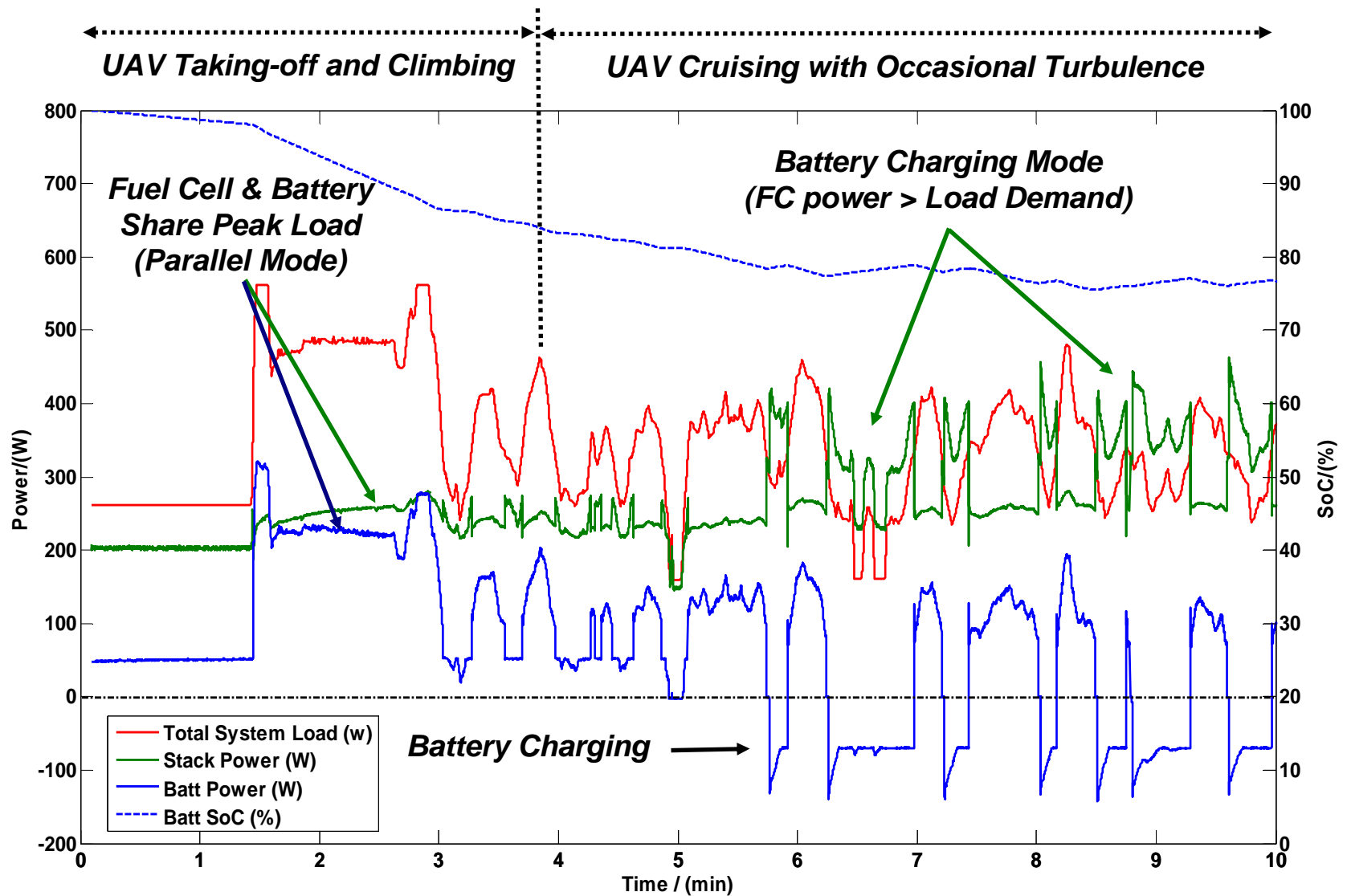

Simulation Test Vs. HiL Test with Actual Hardware

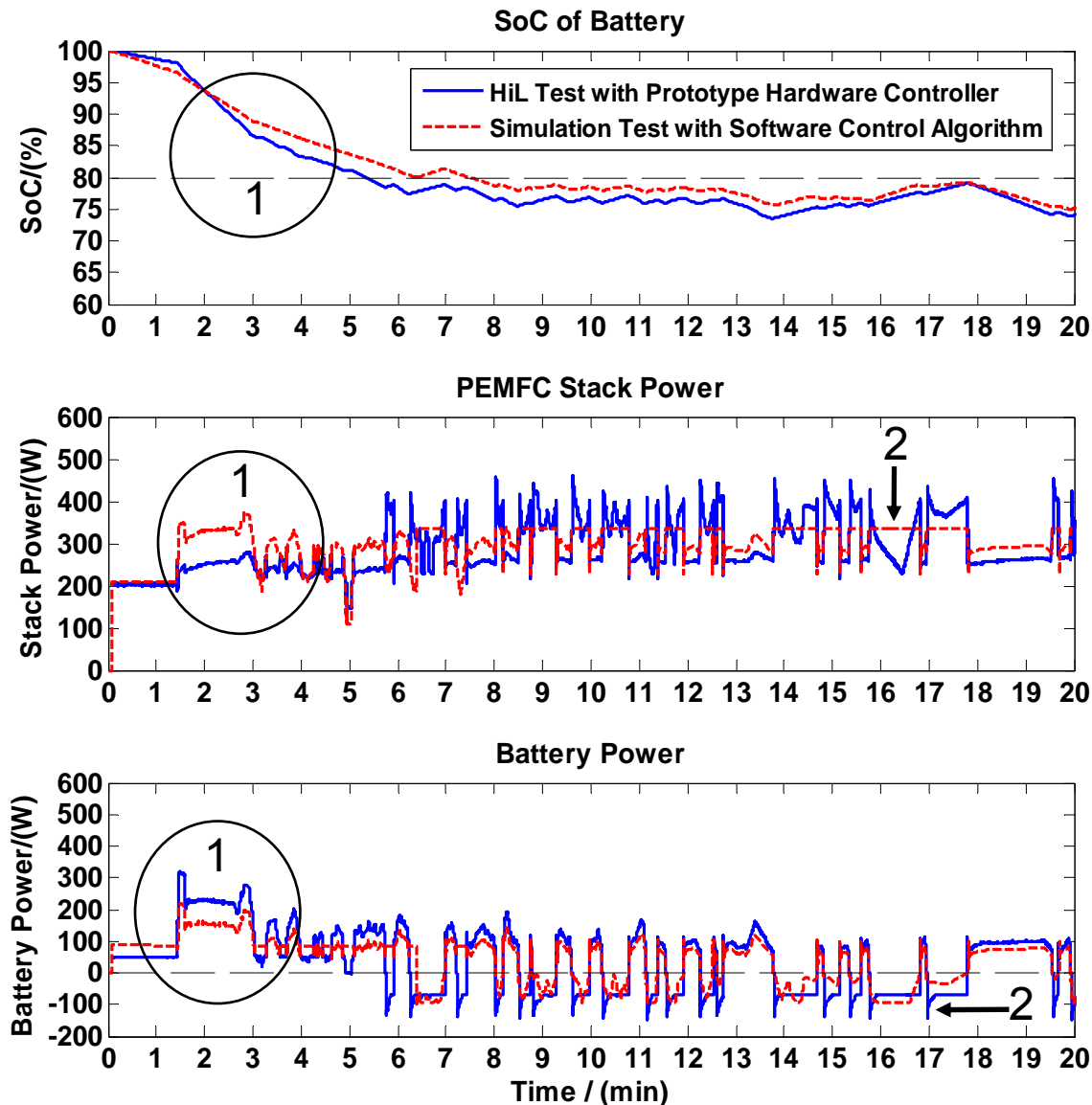

Simulation Results:

- Data based on new stack
- Stack provides more power during parallel mode of operation
 - ⇒ Less battery power is used therefore battery discharge is slower [1]
- Ideal Software Controller
 - ⇒ Better control of stack (load Leveled) and charging power [2]

HiL Results:

- Measured stack and battery data
- Degraded stack performance (>150+ operating hours)
 - ⇒ Battery provides more power and therefore discharges faster [1]
- Hardware Prototype Controller
 - ⇒ Higher charging inrush current due to iterative control (to be replaced with analog current controller) [2]

PH System Operation with Different Initial Battery SoC

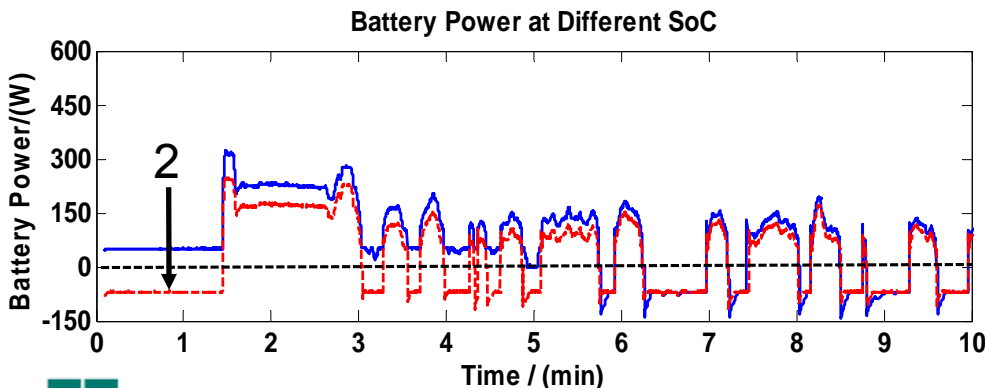
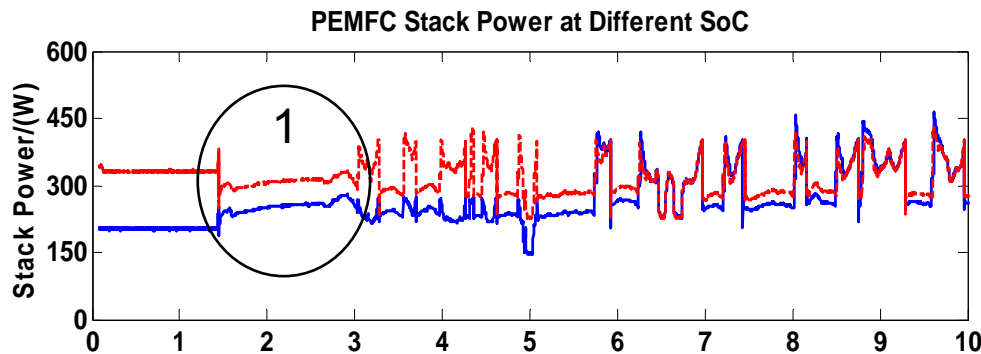
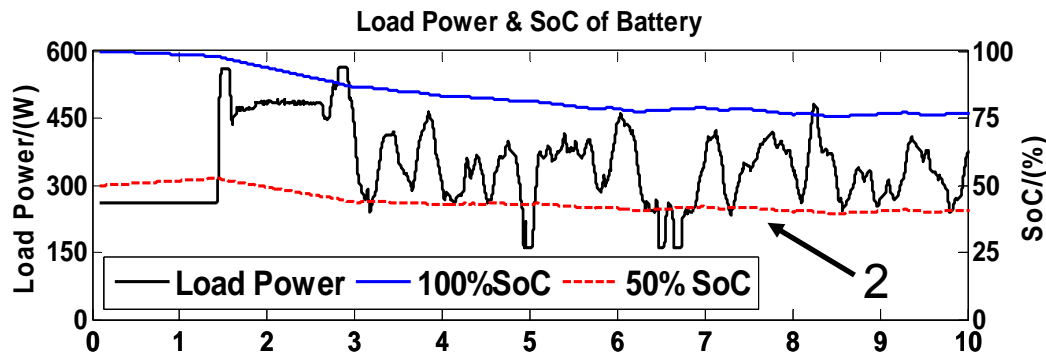

HiL Capability:

- Flexibility in changing system operating conditions/control strategy without hardware modification

100% SoC Test Run

- Higher battery power use
- Stack operates at lower power and higher efficiency [1]

50% SoC Test Run

- Stack provides more power [1]
- Battery starts charging at the beginning of the mission profile and maintains a battery SoC between 50-40% [2]

PH Hybrid System

- Redundant power sources capable of supporting UAV power demand when one source degrades or fails

Partial Hybrid System Benefit

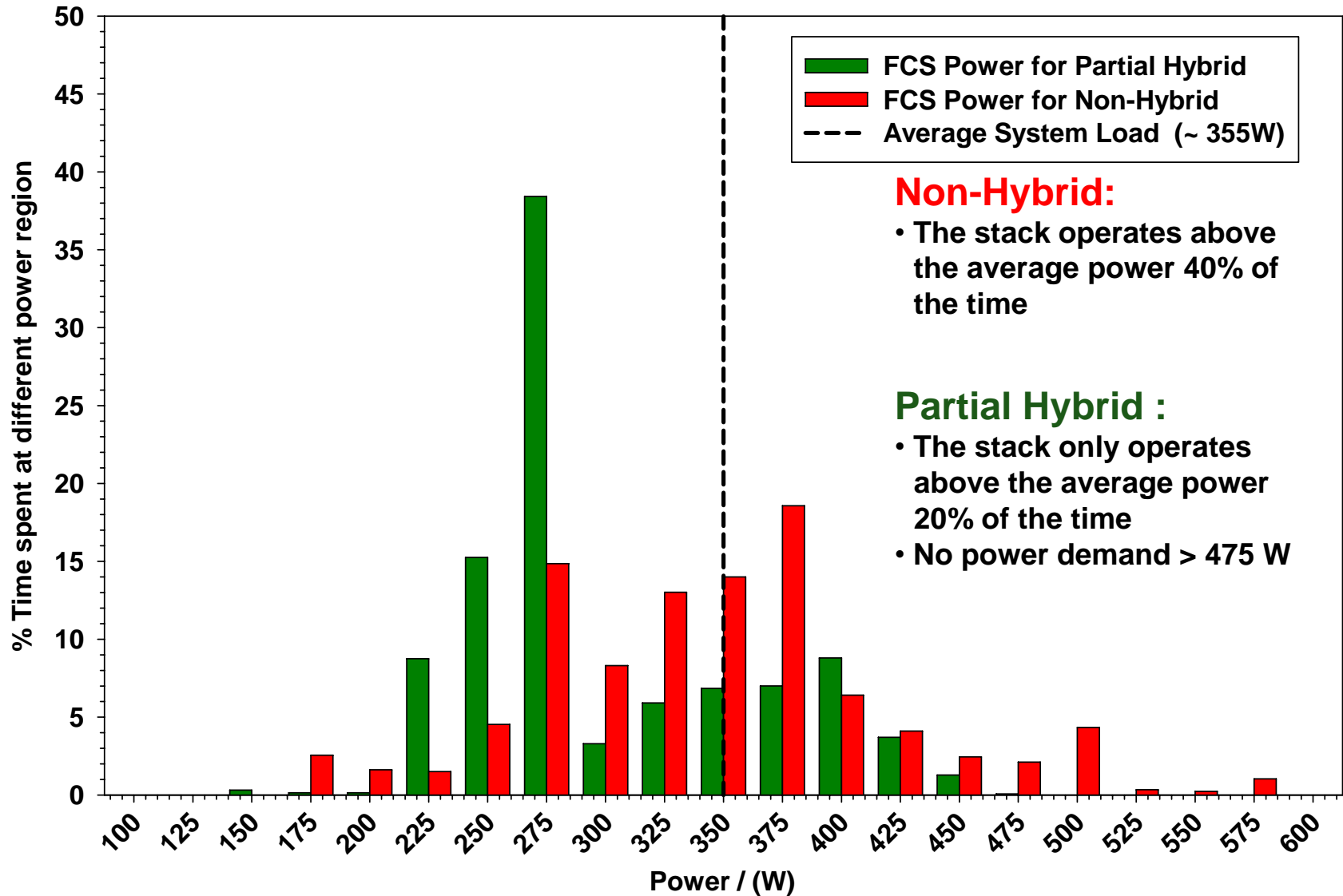

Energy Balance Over a 20 mins Real Time HiL Test

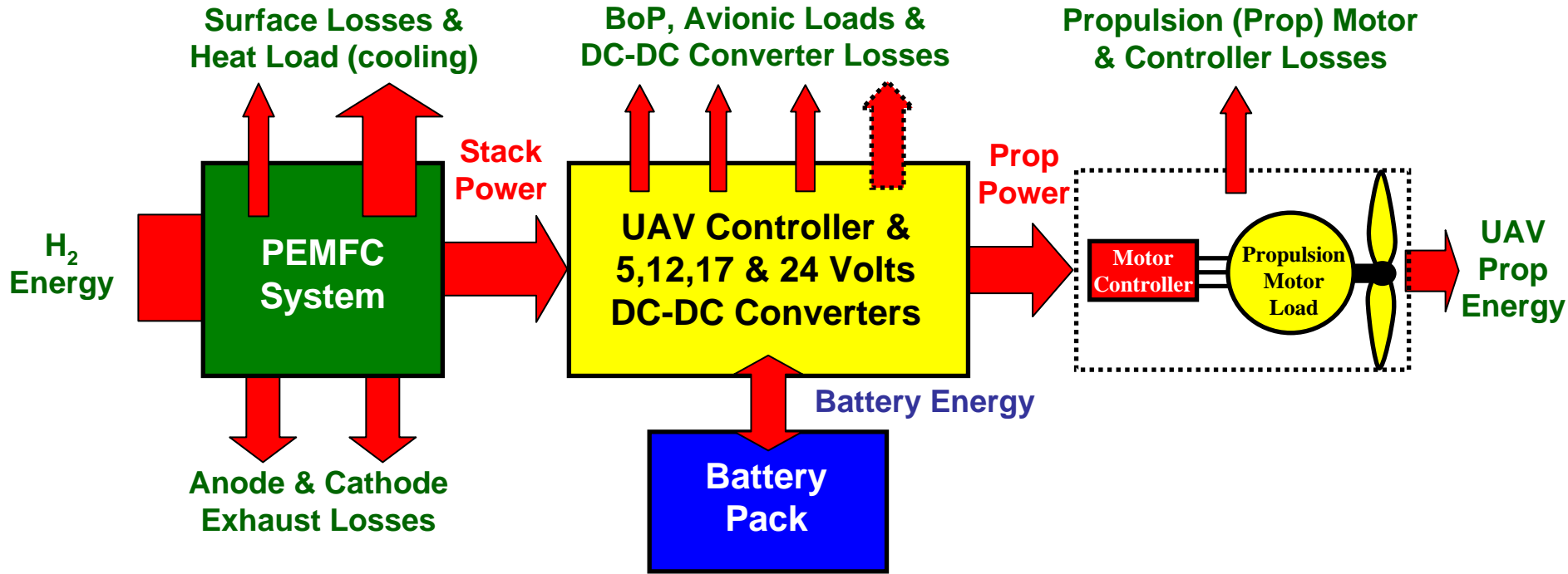

Energy Balance

$$\frac{1}{3600} \times \left[\int_{t_1}^{t_2} P_{IN} dt - \int_{t_1}^{t_2} P_{OUT} dt - \int_{t_1}^{t_2} P_{LOSS} dt \right] = 0$$

Main assumptions:

1. Actual stack current, voltage, cooling and cathode exhaust temperatures are used to estimate the cathode losses & heat load
2. Stack energy balanced based on 98% H₂ utilization

UAV Systems Energy Balance & Flight Duration Summary

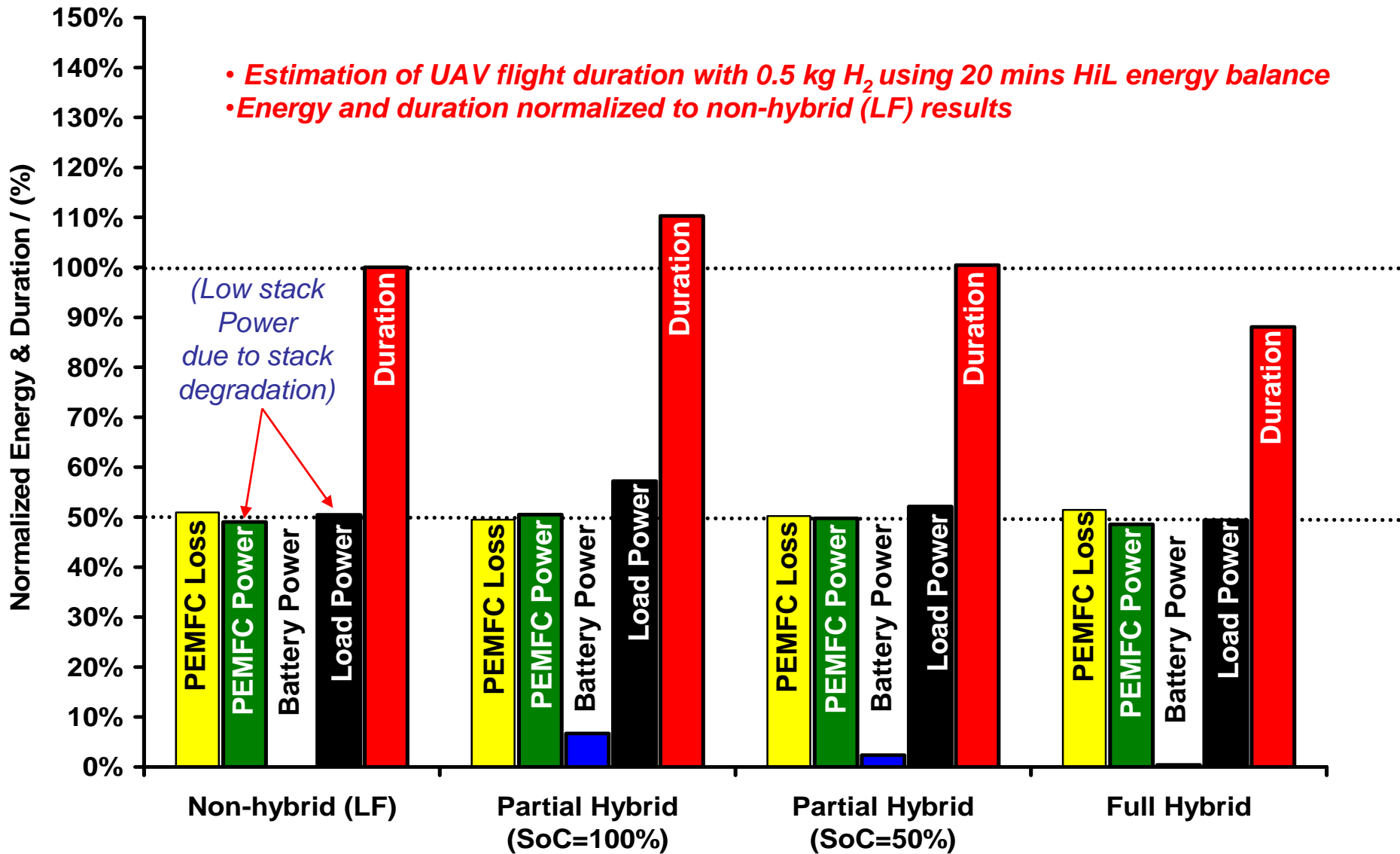

CONCLUSIONS

• A Novel Partial Hybrid (PH) System was Designed and Tested

- Flexible modes of operations (Parallel ↔ Load Following ↔ Charging)
- Uses smaller DC-DC Converter ⇒ Lower power losses and weight penalty
- Maximizes the use of battery energy to minimize the stack power and dynamics during the peak demand by load sharing
- Redundant power sources capable of supporting UAV power demand when one source degrades or fails

• System Simulation Results

- PH UAV system has 2% loss in flight duration in comparison to LF UAV system (non-hybrid)
- PH UAV system has 9% gain in flight duration in comparison to FH UAV system

• HiL Results with Prototype Hardware Controller

- Reduced PEMFC stack power range by 50% above average system power
- PH has 10% and 30% higher flight duration than non-hybrid (LF) and full hybrid (FH) respectively
- Even with an initial SoC of 50%, the PH System has a similar performance as the non-hybrid (LF)
- Implementation of analog current controller to improve control of the charging current would further reduce stack operating power range and increase overall stack efficiency
- Potential increase in stack durability due to a narrow operating power range will be further characterized with life tests

Acknowledgments

Project Supported by Office of Naval Research (ONR) Grants

Grant # N00014-10-1-0310

Grant # N00173-08-2-C008

**Technical Support from
Dr. Guenter Randolf of GRandalytics**

email: g.randolf@grandalytics.com

**Many Thanks
For
Your Attention**