



Electric Vehicle Transportation Center

Islanding Detection and Over Voltage Mitigation using Wireless Sensor Networks and Electric Vehicle Charging Stations

Mr. Alireza Eshraghi
Mr. Shawyun Sariri
Dr. Volker Schwarzer
Dr. Reza Ghorbani

Department of Mechanical Engineering
For

Hawaii Natural Energy Institute,
University of Hawaii at Manoa
1680 East West Road, POST 109
Honolulu, HI 96822
Email: rezag@hawaii.edu

Submitted to:

Dr. David Block
Florida Solar Energy Center
University of Central Florida
1679 Clearlake Road
Cocoa, FL 32922
Email: block@fsec.ucf.edu

Report Number: HNEI-08-15
June 2016

The contents of this report reflect the views of the authors, who are responsible for the facts and the accuracy of the information presented herein. This document is disseminated under the sponsorship of the U.S. Department of Transportation's University Transportation Centers Program in the interest of information exchange. The U.S. Government assumes no liability for the contents or use thereof.



1. ABSTRACT

An islanding condition occurs when a distributed generation (DG) unit continues to energize a part of the grid while said part has been isolated from the main electrical utility. In this event, if the power of the DG exceeds the load, a transient over voltage (TOV) will occur. The adverse effects of TOVs and islanding require that sub-circuits within a power grid not only allow the detection of islanding and TOVs, but also mitigate the over voltages while having the ability to disconnect DG from the grid, if necessary. This paper proposes a solution to this problem based on wireless sensor networks (WSN) and the use of electric vehicle (EV) charging stations as their central communication hubs. Using a simulation, EVs connected to the charging stations are fast-acting loads for the mitigation of TOVs.

2. INTRODUCTION

As more DG becomes part of the power grid infrastructure, it is important to understand how the large-scale use of DGs will affect grid operations. A lack of adequate network protocols and regulations related to islanding allow for potential network instabilities [1]. Islanding and subsequent TOVs are critical risks associated with the increasing implementation of DGs.

TOVs might occur when a photovoltaic (PV) system, or other DG units, continues to feed power into a circuit that has been isolated from the main grid [2]. When DG power exceeds the overall load of the isolated circuit, TOVs can reach critical operating conditions, as illustrated in Figure 1.

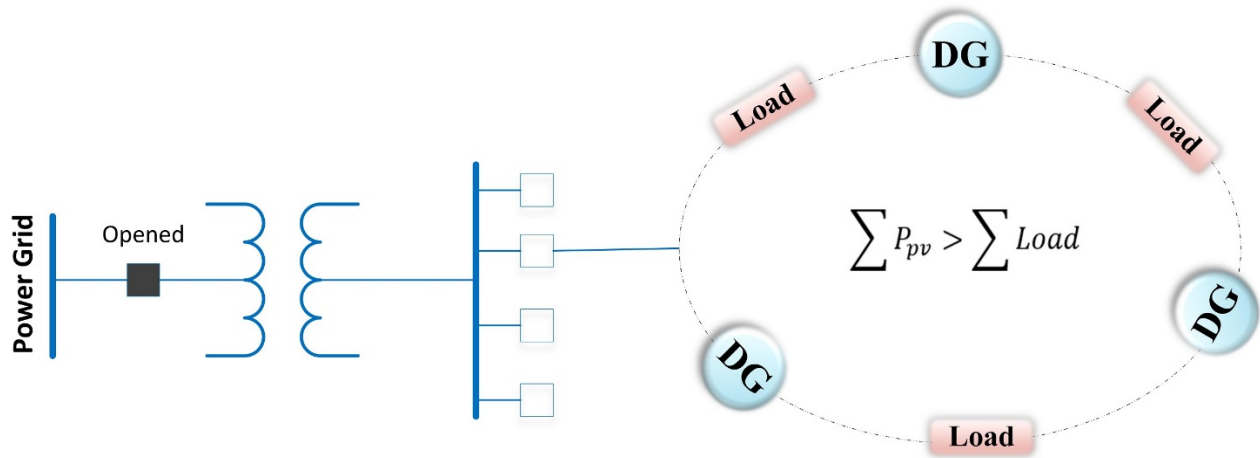

Figure 1: Islanding with transient over voltages.

Several situations can cause TOVs. These may include, but are not limited to:

- A change of protocol on the part of the energy provider
- Equipment failures

- Lightning

Islanding has been known to cause adverse situations such as personal safety hazards, equipment damage, grid interference, and power quality issues [3]. Therefore, it is imperative to find effective methods that will allow for the avoidance or at least the mitigation of over voltages, which will allow for a more consistent and reliable power network. IEEE-1547, UL1741 and IEC-62116 are some of the standards that provide guidance as related to implementing DGs into a pre-existing network infrastructure [4, 5, 6].

Several mitigation techniques that have been proposed to avoid over voltages. The Hawaiian Electric Company (HECO) has proposed two mitigation options to minimize the potential of TOVs [7]. These methods are based on instantaneously switching off PV inverters when TOVs are detected, which will allow for the protection of utility and/or customer equipment.

Using PV inverters with the ability to switch off their power supply after transient voltages are detected is a potential solution. Currently, most modern day inverters have this feature. Another option involves the installation of fast-acting automatic transfer switches (ATS) for inverters that do not have the built-in ability to turn off automatically when TOVs are measured. The requirements of HECO for the aforementioned options is that the device will trip within one cycle, or when the voltage is more than 120 percent of the nominal value [7].

For the IEEE1547 and the UL-1741, a two-second response time (or faster) is required for islanding protection [8-9]. In an islanding event, the risk of TOV is related to the minimum load to generation ratio (MLGR). The MLGR is defined as an annual minimum load on the relevant power system section divided by the aggregate DGs capacity within that section of the infrastructure.

For larger MLGRs, the risk of TOV in an islanding event is much smaller. The risk levels are very low for a MLGR greater than 4, moderate for a MLGR between 2 and 4, and very high when the MLGR is less than 2 [10].

When TOVs occur in a network, they must be addressed with mitigation. A relevant solution would be to add significant, fast-responding loads to the network. EV charging stations, which can also be used as communication hubs, are ideal load controllers for this scenario because they can quickly utilize the capacities of the attached EV batteries as additional network loads, if not already being charged. Whenever islanding is detected and TOVs have occurred, the instantaneous charge of the EV batteries acts as an additional network load, allowing for voltage mitigation.

Fast detection methods for TOV and islanding, as well as communication protocols for voltage mitigation are needed for the aforementioned scenario.

Passive methods are based on monitoring of the local variables within the grid and comparing them to predetermined thresholds. On the other hand, in an active method, a small disturbance is injected into the system, and the response is monitored in order to decide whether islanding has occurred, or not [2, 3, 13, 14].

Several failures have been reported regarding existing systems used to implement anti-islanding protection [15]. Hence, DG devices using on/off switches to prevent transient over voltages cannot be considered entirely reliable.

Communication methods are based on transmitting data between the grid and DGs and should not have any adverse effects on power quality and network reliability. A common wire-based communication protocol is power line carrier communication (PLCC). It uses a transmitter installed on a line with a protection switch and a receiver located near a PV inverter. The transmitter will intermittently send a signal to the receiver using a specific frequency with the power line acting as the communication channel. As long as the receiver can obtain the signal from the grid, the system is operating in a normal voltage range. Any interruption to the communication signal will result in the initiation of a disconnect command being sent from the receiver to the inverters. This method provides reliable islanding detection, however, it has yet to be commercialized. One of the main reasons for a lack of commercialization is due to the high cost of the broadcasting equipment. In addition, the PLCC method requires costly physical changes to already existing power line infrastructure [16, 17, 18, 19].

In this report, a wireless communication method to detect and mitigate TOVs, using the IEEE802.15.4 standard and utilizing EV charging stations as control hubs, is examined. In the proposed method, the charging station based controller unit monitors the network for islanding by analyzing wirelessly transferred data from sensor units within the network. When TOVs are detected, the controller unit initializes rapid EV battery charging based on a pre-determined routine to add additional loads to the network.

3. NETWORK TOPOLOGY

The distance between the transformer and an inverter in a section of a network grid is usually less than 100 meters. One-hop ZigBee wireless communication devices feature a broadcasting coverage of more than 100 meters under normal operating conditions. Therefore, it is feasible to use low-latency ZigBee technology for sensor communication and data transfer within secondary networks.

A “star network topology”, as illustrated by the example in Figure 2, is the preferred communication setup when the network area is small. This topology consists of a personal area network (PAN) coordinator as a single central controller and a number of clients connected to sensors and actuators. All devices in this topology communicate with and via the central controller. EV charging stations can straightforwardly be utilized as PANs as they feature sufficient processing power, control capabilities, and a direct connection to the EV battery.

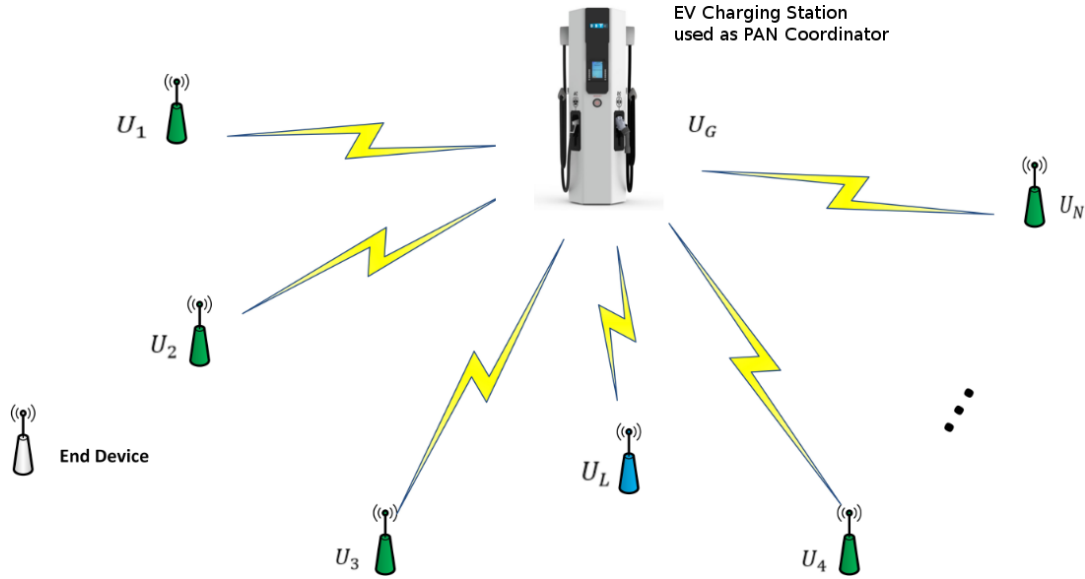

Figure 2: Proposed network communication topology ("star topology"). PAN is the personal area network, U_{N+1} units are clients, U_G is the unit coordinator and generator in this example.

In a star topology setup, the network chooses a unique PAN identifier in order to operate independently, and without interference from adjacent networks. In Figure 2, the coordinator is denominated as U_G , which is integrated into the EV charging station, and the U_{N+1} units are the clients. The proposed model uses a non-beacon enabled mode because the operations are not regulated based on back-off period slots. The PAN coordinator, as defined by IEEE802.15.4, can support anywhere from three to seven clients, which is sufficient for islanding detection and over voltage mitigation. Each data set is sent once, and there is no retransmission policy because the communication algorithm will measure and compare the voltage levels multiple times during each individual cycle. As a result of the multiple measurements, a destination node will not receive the data. Instead, the algorithm simply ignores the data, and looks at the next time interval.

Nodes typically operate in a saturation condition, which means that during their activation time they will always be sending signals. When distributed power generation does not occur, the sensors will not operate [20, 21, 22, 23, 24].

The communication error of the proposed setup can be quantified by the following equation:

$$P_{error} = f(P_d, P_c, P_l) \quad (1)$$

The efficiency of communication protocol depends on several factors:

- Occurrence of bad signals due to channel failure (P_d)
- Error occurrence due to signal collisions in the transmission line (P_c)
- Errors caused by line noise (P_l)

P_1 depends on the signal to noise ratio (SNR), which is a function of the symbol-error probability (P_s) for the aforementioned modulation. The PAN coordinator constantly broadcasts current voltage levels to the nodes. If an abnormal situation is detected, the nodes will send data to the coordinator, which then investigates the correlation between the measured discrepancies and the reliability quantified by P_1 .

There are two methods for controlling this error. Option one involves adding redundancy to transmit messages, while the second option uses acknowledgments and retransmissions. Each WSN can be operated separately, or in a hybrid codification. Because the controller needs to act instantaneously in the event of islanding, the proposed algorithm cannot use either of the two proposed methods because both add too much latency to the communication. However, the error can be decreased by implementing a dedicated sensor for each PV inverter. By using these sensors in tandem with the aforementioned algorithm, efficiency is increased because the effects of channel noise and disturbances are reduced [25, 26, 27].

4. ISLANDING DETECTION AND VOLTAGE MITIGATION

Figure 3 shows a schematic diagram of the proposed solution for islanding detection. Each ZigBee sensor is assigned to a dedicated PV panel (U_1 - U_N). Furthermore, the secondary network contains two additional ZigBee sensors, one on each side of the main network switch (U_L and U_G).

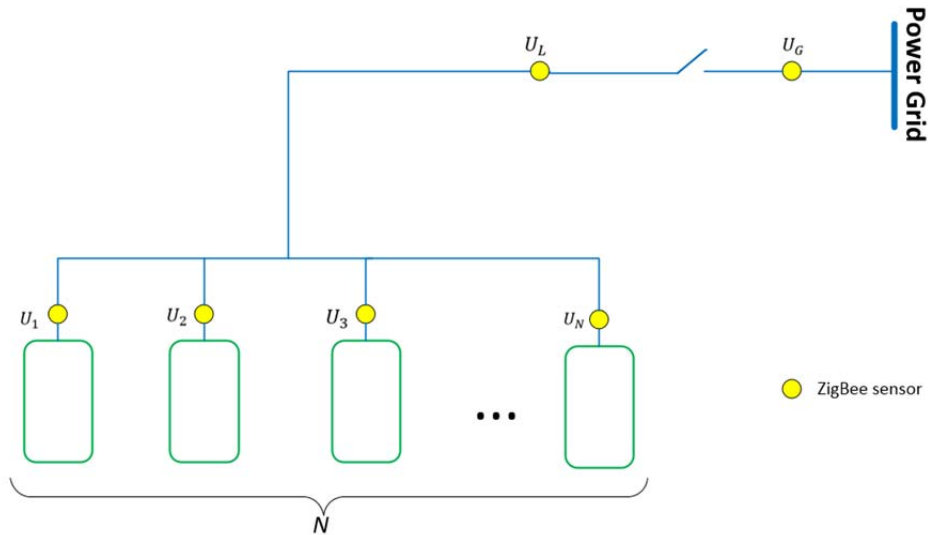

Figure 3: Secondary power network equipped with ZigBee sensors for efficient over-voltage mitigation.

A. Islanding Detection

The PAN coordinator monitors the network voltage at the EV charging station. It is programmed to instantaneously send the measured voltage signal to all clients for each time step. The operating voltage range is defined as $0.88V_g$ to $1.1V_g$. Voltages outside of this range may indicate a network over-voltage. When clients receive a voltage signal from the coordinator, they

will then compare the received voltage (V_g) to the locally measured one (V). If the local voltage is in the range, the device output (O_i is the output of device number i) will be set to zero. If not, the value will be one which means that this sensor detected the islanding situation. At the same time, the coordinator uses high frequency scanning to route the communication network for possible signals from the clients. For the energy issue and reducing the number of transmissions between each client and coordinator, the output will be sent to the coordinator only if it is changed in comparison with the last time step. If the coordinator does not hear from a client in the current time step, then it will use the value from the previous time step for that client. On the coordinator side, the number of devices that reported the islanding condition is counted and the result is compared with the threshold value. If it is less than the threshold, the coordinator decides that islanding has not occurred ($D_e = 0$) and the normal operation is continued. The power system controller is entered in the islanding mode ($D_e = 1$) when the counted value is greater than the threshold. Figs. 4 and 5 illustrate this logic.

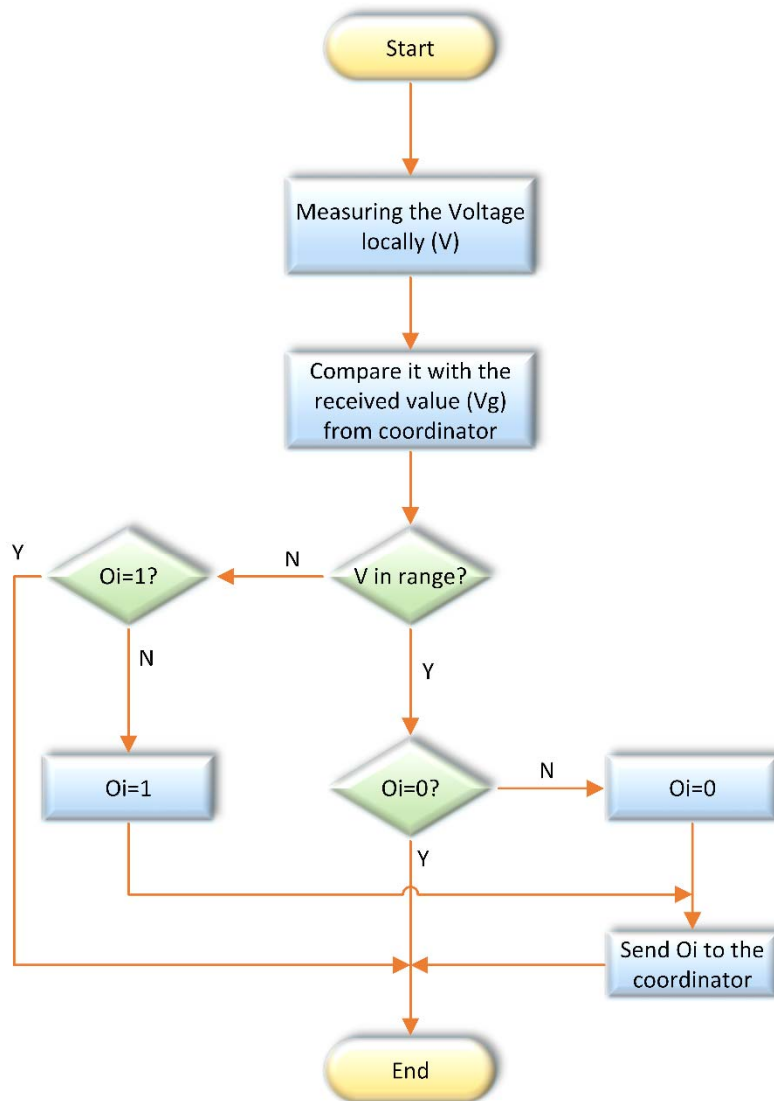

Figure 4: PAN Network Logic.

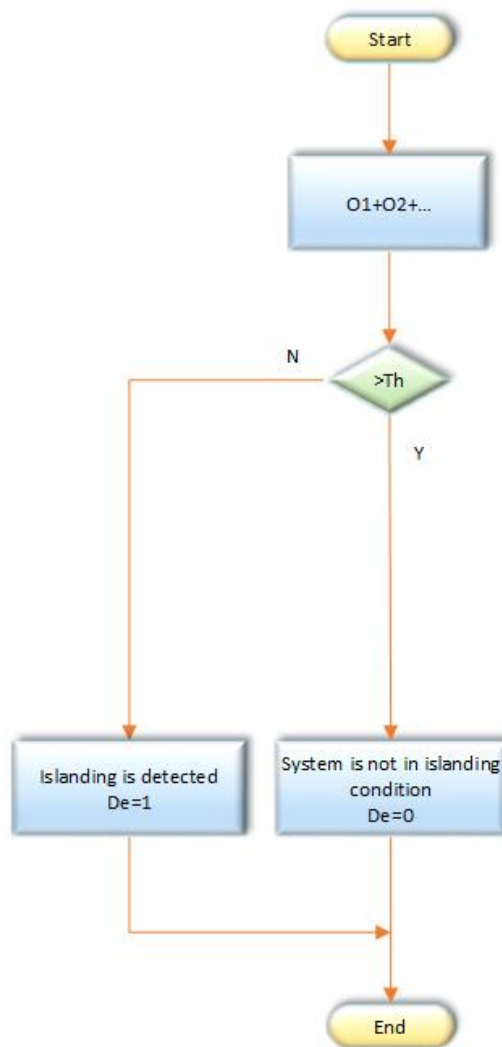

Figure 5: Schematic illustrating coordinator detection.

B. Tripping the Inverters and Mitigating the Voltage

A predetermined set of instructions are programmed into the coordinator, so that when islanding is detected, the coordinator can implement the appropriate response to mitigate relevant issues. Two possible mitigation methods are used.

The first mitigation option is to instantaneously turn off, ‘tripping’ the PV inverters in each unit to mitigate voltage peaks in the fastest possible manner. After the coordinator detects islanding, it will send a trip command to each ZigBee sensor. The sensors will then trip their respective inverters.

The second option is to add additional loads to the network, which are controlled by a microprocessor in the EV charging station, and can be instantaneously connected to the network. This allows the voltage to be kept in a safe operating range. The proposed method requires

additional auxiliary loads of various sizes within the secondary network. Voltage rises in the network are mitigated by instantaneously adding these loads to the network. Figure 6 illustrates this process.

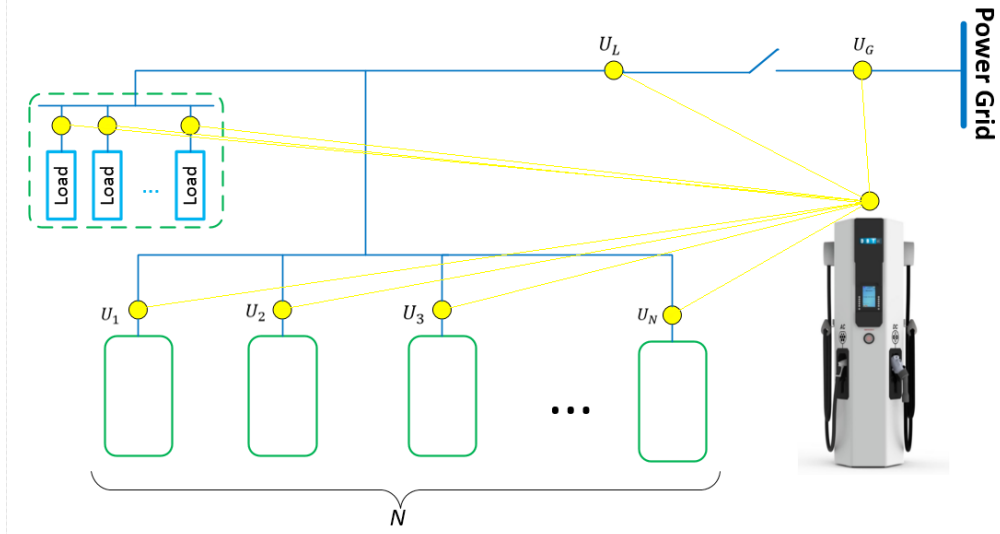

Figure 6: TOV mitigation using various loads.

Each load can be controlled remotely by the coordinator. After islanding is detected, the additional loads will enable mitigation of the over voltages. The control algorithm of the coordinator is optimized to find the optimal combination of loads that will keep the voltage level in the defined range in the shortest amount of time. Figure 7 shows a flowchart for the aforementioned process.

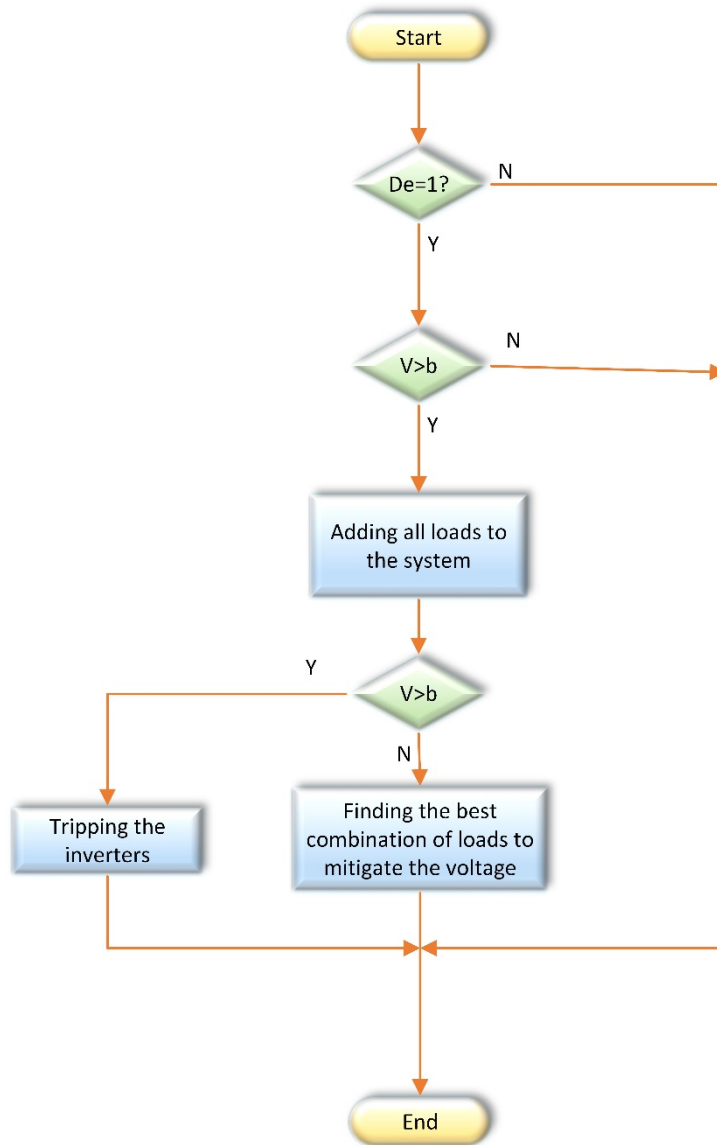

Figure 7: TOV mitigation logic using added loads ($b=1.1V_g$).

If the controller is not able to mitigate the voltage to a safe operating range using all of the available loads, it will then revert to option 1 and trip off all available DG inverters within the network. This allows the ability to minimize damage to network infrastructure and household appliances.

5. SIMULATION RESULTS

Powersim's simulation environment (PSIM) was used to simulate the proposed islanding detection methodologies with a simplified model of a secondary network, including household loads with adjacent DG, and an EV charging station used as the PAN controller. PSIM is

currently one of the fastest simulators for power electronics simulation. Its engine enables simulation of various electric circuits in combination with complex control methodologies.

The simulation itself incorporates 10 household loads, each connected to a DG unit, which consists of PV panels and an inverter. To simplify the model, the PV inverters are defined as current sources. An additive white Gaussian noise (AWGN) channel, as well as randomized fault signals, were added to the communication line model to simulate potential disturbances in the frequency band.

Figure 8 depicts the results that occur when the inverters are tripped. In this scenario, PV inverters are disconnected from the network after islanding has been detected by the coordinator.

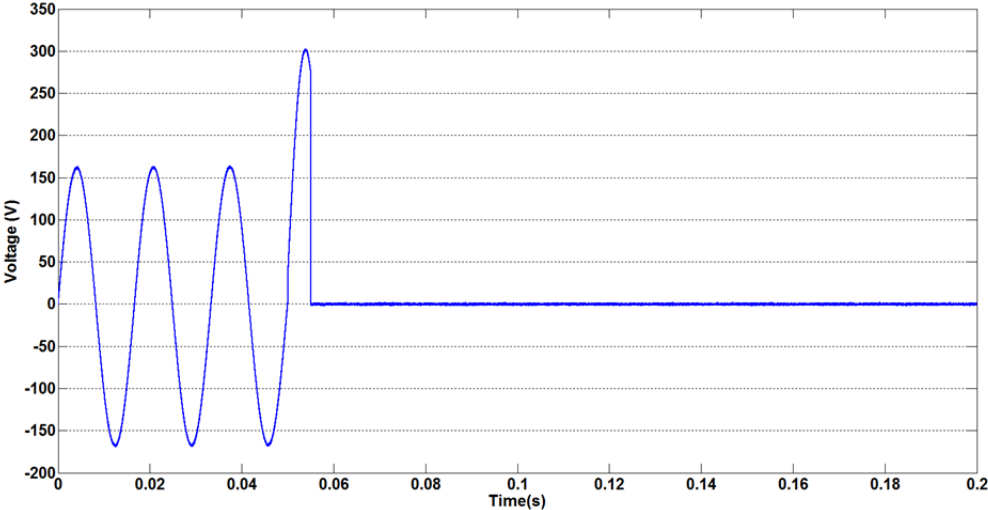

Figure 8: Voltage after inverters are tripped.

The next simulation involves using three loads to mitigate the TOVs. In this scenario, Load1 is set to be smaller than Load2, and Load2 is set to be smaller than Load3. Figures 9 and 10 show the results of a TOV mitigation using this load setup.

In the scenario of Figure 9, the TOVs caused by the distributed generation after islanding is so large that the capacity of the available loads are insufficient to mitigate the voltages to an acceptable range. After the PAN coordinator in the EV charging station recognizes the lack of available mitigation loads, it instantaneously sends a signal to trip the inverters.

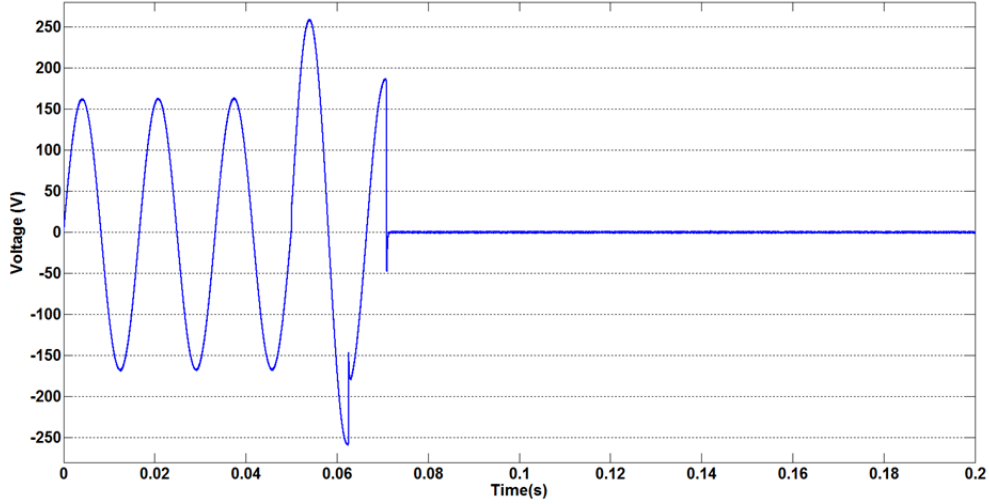

Figure 9: Large TOVs with insufficient available loads.

Figure 10 illustrates a successful mitigation of TOVs utilizing the three additional loads within the simulation. When islanding is first detected, the coordinator determines and implements the best combination of loads by testing various switching combinations. This is done by first adding the largest load aggregation (all loads) to the network and gradually iterating to the smaller capacities until the voltage is sufficiently constrained to the optimal range.

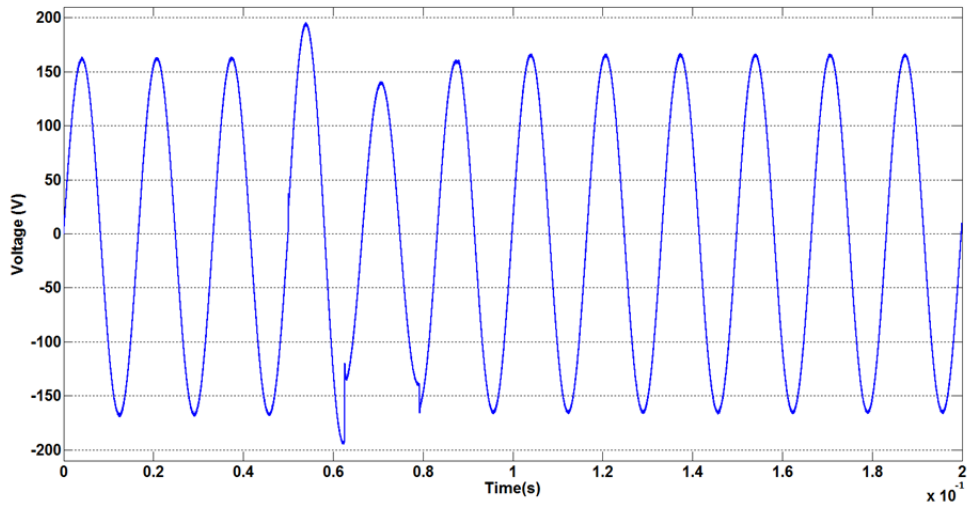

Figure 10: Successful mitigation of transient over voltages using 3 loads with different values

6. CONCLUSIONS

This paper introduces an islanding detection method based on the IEEE 802.15.4 standard. Using a simulation, a linkage of wireless communication sensors and actuators are distributed at various DG inverters and switches within the secondary network, and setup to monitor the network for possible transient over voltages. In addition, the processing capabilities of an EV charging station controller are used to act as a central coordinator. It was shown that the proposed setup is capable of overcoming typical challenges associated with islanding detection and over voltage mitigation. First, to overcome communication errors, a group of sensors is used in tandem rather than relying solely on one sensor in a section of the network, and hence increases detection reliability. Second, there is an increase in ability to react to various situations because the sensors are distributed throughout the network, and provide instantaneous feedback to the central controller. For example, when islanding is detected, the controller can either decide to trip all the inverters, or add a combination of additional network loads to the network to regulate the voltage to an accepted range. The simulation results indicate that by using the proposed methods, islanding and associated TOVs can be mitigated in an appropriate and efficient manner.

7. REFERENCES

- [1] T. Aziz, T. K. Saha, and N. Mithulananthan, Analysis and mitigation of transient overvoltage with integration of small scale power-electronic interfaced dg. In Power and Energy Society General Meeting, IEEE, page 18, July 2012.
- [2] A. Timbus, A. Oudalov, C.N.M. Ho, Islanding detection in smart grids, Energy Conversion Congress and Exposition (ECCE), 2010 IEEE, pp. 3631-3637.
- [3] A. Cataliotti, V. Cosentino, N. Ngoctrung, P. Russotto, D. Di Cara, and G. Tine, Hybrid passive and communications-based methods for islanding detection in medium and low voltage smart grids, Power Engineering, Energy and Electrical Drives (POWERENG), Istanbul, pp. 1563-1567, May 2013.
- [4] IEEE 1547: IEEE standards for interconnecting distributed resources with electric power systems, 2003.
- [5] UL 1741: Inverters, Converters, Controllers and Interconnection System Equipment for Use With Distributed Energy Resources.
- [6] IEC 62116: Test procedure of islanding prevention measure for utility interconnected photovoltaic inverters, Ed.1.0, 09 2008.
- [7] Hawaiian Electric Company. Transient over-voltage mitigation: Explanation and mitigation options for inverter-based distributed generation projects 10kw. Technical report, 2014.

- [8] P. Barker, “Experiences in integrating PV and other dg to the power system (radial distribution systems)”, 2012. Presentation.
- [9] P. Barker, “Distributed solar integration experiences”, 2013. Presentation.
- [10] T. A. Short, “Electric Power Distribution Handbook”, Second Edition, CRC Press, 2014
- [11] S. Sepasi, R. Ghorbani, and B. Liaw, “A Novel On-Board State of Charge Estimation Method for Aged Li-ion Batteries Based on Model Adaptive Extended Kalman Filter”, Journal of Power Sources, 245 (1), 337-344.
- [12] S. Sepasi, R. Ghorbani, and B. Liaw, “Improved extended Kalman filter for state of charge estimation of battery pack”, Journal of Power Sources, 255 (1), 368-376.
- [13] F. De Mango, M. Liserre, A. DellAquila, and A. Pigazo, Overview of anti-islanding algorithms for PV systems. Part I: Passive methods, Proc. Of Power Electronics and Motion Control Conference, 2006, pp. 1878-1883.
- [14] F. De Mango, M. Liserre, A. DellAquila, and A. Pigazo, Overview of anti-islanding algorithms for PV systems. Part II: Active methods, Proc. Of Power Electronics and Motion Control Conference, 2006, pp. 1884-1889.
- [15] ESA. Distributor safety bulletin - embedded generation safety (bulletin dsb-07/11). Technical report, Electrical Safety Authority, 2011.
- [16] A. Etxegarai, P. Egua, I. Zamora, Analysis of Remote Islanding Detection Methods for Distributed Resources, International Conference on Renewable Energies and Power Quality, ICREPQ11, 13-15 April, Las Palmas de Gran Canaria (Spain), 2011.
- [17] M. Ropp, K. Aaker, J. Haigh, N. Sabhah, Using Power Line Carrier Communications to Prevent Islanding, Proc. of the 28th IEEE Photovoltaic Specialist Conference, 2000, pp. 1675-1678.
- [18] O. Abarrategui, I. Zamora, D. Larruskain, and A. Iturregi, Power line carrier communications and its interest in the current power grid scenario, ICREPQ, 2008.
- [19] R. Teodorescu, M. Liserre, P. Rodriguez “GRID CONVERTERS FOR PHOTOVOLTAIC AND WIND POWER SYSTEMS”, New Delhi, India: John Wiley & Sons, Ltd.
- [20] ZigBee Alliance, <http://www.caba.org/standard/zigbee.html>.
- [21] P. Parikh, M. Kanabar, T. Sidhu, Opportunities and challenges of wireless communication technologies for smart grid applications, in Proc. IEEE Power and Energy Society General Meeting, Minneapolis, MN, July 25-29, 2010, pp.1-7.

- [22] C. Buratti and R. Verdone, "Performance analysis of IEEE 802.15.4 non beacon-enabled mode," *Vehicular Technology, IEEE Transactions on*, vol. 58, no. 7, pp. 3480-3493, 2009.
- [23] A. Koubaa, M. Alves, and E. Tovar, Modeling and worst-case dimensioning of cluster-tree wireless sensor networks, in *Proc. 27th IEEE Int. RTSS*, December 2006, pp. 412-421.
- [24] G. Anastasi, M. Conti, and M. Di Francesco, Extending the lifetime of wireless sensor networks through adaptive sleep, *IEEE Trans. Ind. Informat.*, vol. 5, no. 3, pp. 351-365, August 2009.
- [25] M. Di Francesco, G. Anastasi, M. Conti, S. Das, and V. Neri, "Reliability and Energy Efficiency in IEEE 802.15.4, ZigBee Sensor Networks: An Adaptive and Cross-layer Approach," *IEEE Journal on Selected Areas in Communications*, vol. - to appear (3rd Quarter 2011).
- [26] P. Park, P. Di Marco, P. Soldati, C. Fischione, and K. Johansson, A generalized markov chain model for effective analysis of slotted IEEE802.15.4, in *Proc. 6th IEEE International Conference on Mobile Adhoc and Sensor Systems (MASS 09)*, October 2009, pp. 130-139.
- [27] J. Kurose and K. Ross, *Computer Networking - A Top-Down Approach Featuring the Internet*, 5th ed. Addison-Wesley Professional, 2009.
- [28] B. Sun, J. Mei, and J. Zheng, "A novel islanding detection method based on positive feedback between active current and voltage unbalance factor", *IEEE Innovative Smart Grid Technologies - Asia (ISGT Asia)*, pp. 31-34, Kuala Lumpur, May 2014.
- [29] J. Shen, H. Jou, and J. Wu, "Grid-Connected power converter with islanding detection and active power filter functions", *Proc. IEEE Int. Symp. Power Electron. Distrib. Generation Syst.*, pp. 501 -506, 2010.
- [30] Sung-I Jang, Kwang-Ho Kim, "An islanding detection method for distributed generations using voltage unbalance and total harmonic distortion of current," *Power Delivery, IEEE Transactions on*, vol.19, no.2, pp.745-752, April 2004.